

GLASSTEC PRICE LIST

MAY 1, 2007

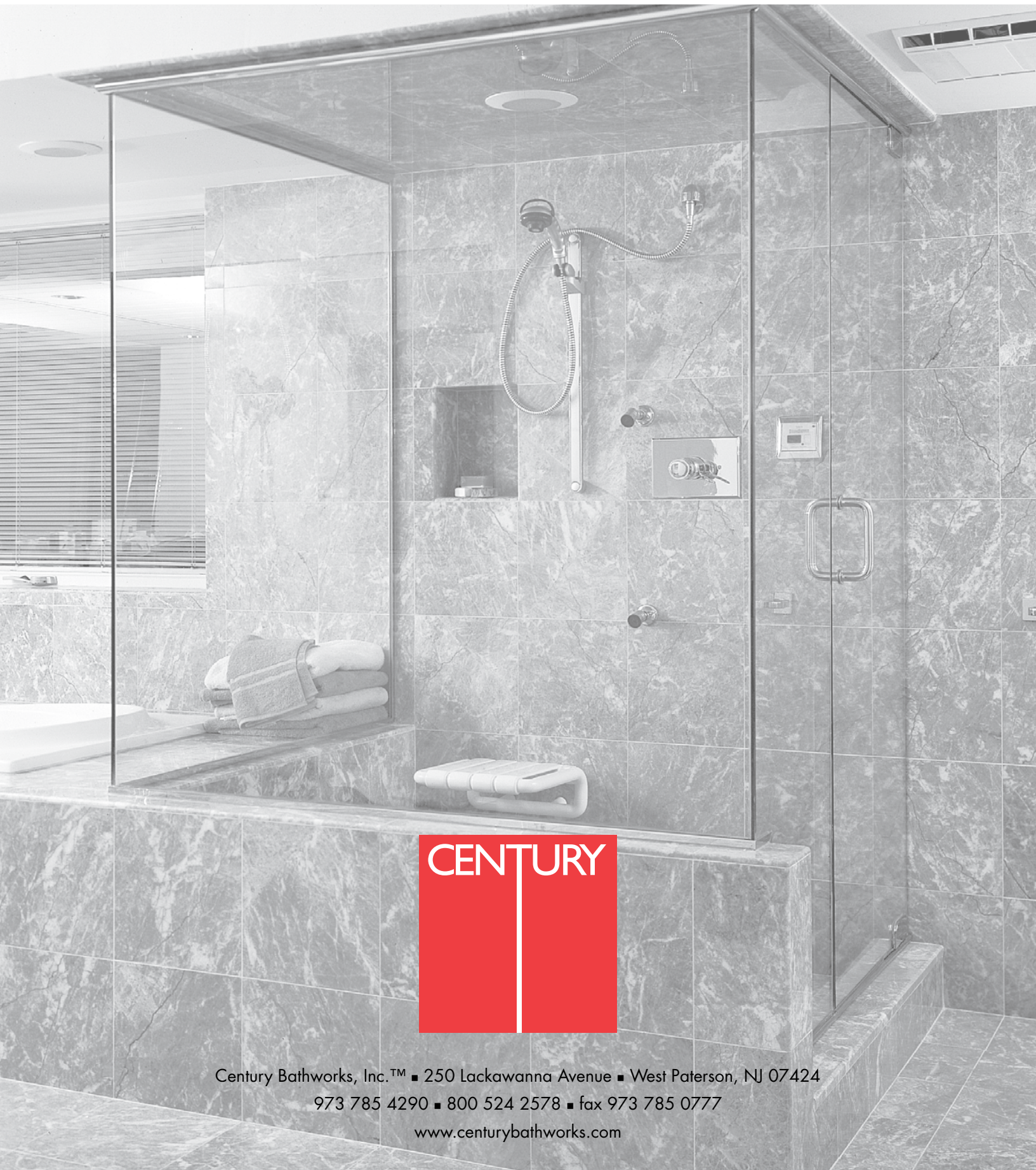

CENTURY

Century Bathworks, Inc.™ ■ 250 Lackawanna Avenue ■ West Paterson, NJ 07424

973 785 4290 ■ 800 524 2578 ■ fax 973 785 0777

www.centurybathworks.com

INDEX

Terms and Conditions	1
Sliding Enclosures - Solid Brass	2-3
Aluminum Pivot Hinge Doors	4-5
Brass Pivot Hinge Doors	6-7
Brass Wall Mount Hinge Doors	8-9
Brass Glass to Glass Hinge Doors	10-11
Jamb Mount Door / Spray Panels	12
Ordering Method	13
Steam Vents	14-15
Upgrades - Finishes; Handles; Knobs	16
Upgrades - Towel Bars; Clips	17
Upgrades - Glass Options	18
Glasstec Quick Ship Program	19
Notes	20
Locations and Contacts	21

TERMS AND CONDITIONS

STANDARD PAYMENT TERMS:

30 days net.

DEPOSIT REQUIREMENTS:

A 50% deposit is required on all Solid Brass Enclosures. Balance is subject to standard payment terms & conditions.

PRICES:

This price book includes suggested retail list prices and are effective as of May 1, 2007. All prices, discounts, quotations and specifications are subject to change without notice.

PAST DUE ACCOUNTS:

Past due accounts will be placed on "hold". Orders in house will not be processed until the account is within terms.

SHIPMENTS/DELIVERIES:

Customers not in Century's delivery region will be subject to minimal freight charges. Geographic areas outside of Century's delivery zones will be F.O.B. West Paterson, NJ (or nearest Century Warehouse) and will be serviced by Common Carrier deliveries. Century will select carriers by their ability to provide quick delivery and handle our product properly with less risk of damage. Merchandise becomes the property of the purchaser who assumes full risk for loss or damage in transit once the merchandise is placed with the transportation company. We maintain the right to designate carriers, however purchaser may request his/her own carrier.

CANCELLATION / RETURN POLICY:

Orders cancelled while in any stage of production shall be subject to appropriate cancellation charges or forfeiture of the deposit. Defective material only will be subject to return. Requests for a Return Goods Authorization (RGA) must be made within 60 days of the date of invoice. Items accepted for return must be properly packaged.

Glasstec/Brassline units are custom made and will not be eligible for return due to the individualized design of each enclosure.

WARRANTY:

Century warranties our Glasstec enclosures to be free of defects in workmanship for a period of one (1) year. Liability on any claim of defective design and workmanship is limited to the replacement of defective material only. Century is not responsible for labor or other installation costs for the repair or replacement of defective merchandise.

Damage attributed to abuse; misuse, careless handling, alteration, improper installation or maintenance, abnormal chemical cleaning, abrasives, discoloration or stains due to improper water chemistry, or accidental damages are not covered by this warranty.

SLIDING ENCLOSURES - SOLID BRASS

Standard Features on G-CT, G-CT-636, G-CS, and G-CS-1648 Models

- Solid brass variation of our popular aluminum CENTEC Series
- Complete with solid brass header, side jambs, easy clean track & hardware
- 1/4" and 3/8" Clear glass
- Round designer header
- **Standard Finishes:** Polished Chrome; Satin Chrome; Polished Nickel; Satin Nickel
- Modern towel bars

AVAILABLE UPGRADES FOR G-CT, G-CT-636, G-CS, AND G-CS-1648 MODELS

Please see the red pages in the back of this catalog for upgrade information and pricing

Glass Upgrades Available:

(see page 18 for pricing, clear glass standard)

Antique	Bisselux	Bronze Tint	Bubble
Grey Tint	Rain	Starphire	Aquatic
Cascade	Mist	Vertical Wave	GeoGlass
Glue Chip	Pattern 62*	Reed* (* 1/4" glass only)	

Diamond Fusion Protective Coating - \$7 per sq ft

1/2" Glass Upgrade NOT Available

Metal Finish Upgrades Available:

(standard finishes listed above)

Colortec Paint - \$150 per door/panel
 Custom Paint - \$350 setup + \$150 per door/panel
 Antique Brass, Brushed Bronze & 24K Gold - call factory

Towel Bars Upgrades Available:

(modern towel bars standard, see page 17)

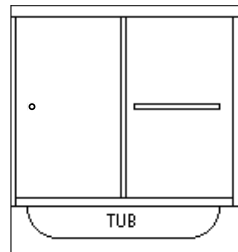

- Traditional - \$95
- Spindle - \$200
- Bow - \$95 (18" & 24" only)

Single towel bar and 3/4" inside finger pull available at no extra charge.

Optional Flat Beveled Header - No Charge:



Round Designer Header Standard



Flat Beveled Header

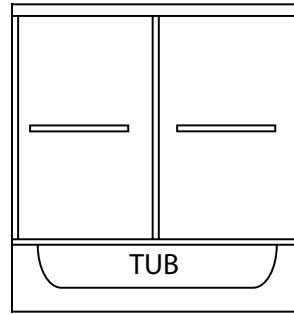

G-CT
Tub Enclosure

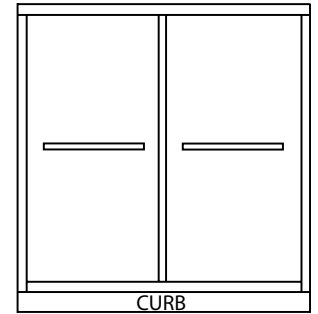

G-CS
Shower Stall Enclosure

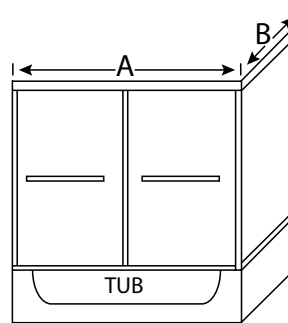

G-CT-636
Corner Tub Enclosure

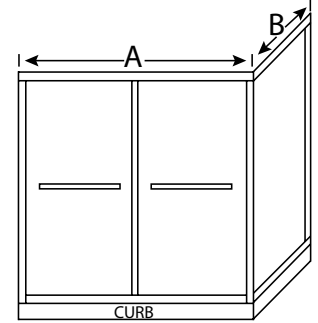

G-CS-1648
Corner Shower Stall Enclosure

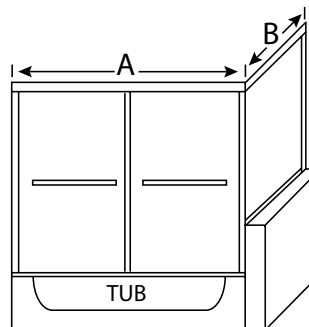

G-CT-636-B
Corner Tub Enclosure with Buttress Return

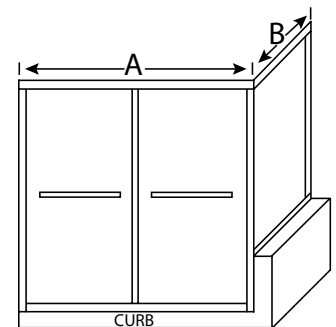

G-CS-1648-B
Corner Shower Stall Enclosure with Buttress Return

Glasstec Sliding Doors come standard with a solid brass round header. A solid brass flat beveled header is available at no extra charge. Please specify flat header when ordering. All orders unspecified will include round header.

SLIDING ENCLOSURES - SOLID BRASS



Standard Finishes:

Polished Chrome
Satin Chrome
Polished Nickel
Satin Nickel

Standard Glass:
Clear

G-CT • 1/4" Glass

72" height	2880	3054	3204	3392
68" height	2800	2974	3120	3308
64" height	2722	2892	3056	3222
62 3/4" height	2696	2865	3010	3192
57 3/4" height	2554	2718	2862	3042
56" height	2514	2678	2821	3000
WIDTH	54"	60"	66"	72"

G-CS • 1/4" Glass

80" height	2716	2896	3048	3228	3380	3576
76" height	2630	2808	2958	3136	3286	3478
72" height	2554	2730	2880	3054	3204	3394
70 3/4" height	2532	2706	2854	3028	3176	3364
68" height	2480	2654	2800	2974	3120	3308
66" height	2444	2614	2762	2932	3080	3264
WIDTH	42"	48"	54"	60"	66"	72"

G-CT • 3/8" Glass

72" height	3324	3546	3722	3958
68" height	3280	3498	3670	3902
64" height	3236	3450	3618	3846
62 3/4" height	3214	3424	3592	3818
57 3/4" height	3092	3296	3462	3680
56" height	3070	3272	3436	3652
WIDTH	54"	60"	66"	72"

G-CS • 3/8" Glass

80" height	3010	3243	3424	3656	3836	4084
76" height	2962	3190	3366	3596	3772	4016
72" height	2926	3150	3324	3546	3722	3958
70 3/4" height	2907	3128	3302	3522	3696	3930
68" height	2890	3108	3280	3498	3670	3902
66" height	2872	3088	3258	3474	3644	3874
WIDTH	42"	48"	54"	60"	66"	72"

G-CT-636 and G-CT-636-B • 1/4" Glass*

72" Height	4957	5209	5474	5612	5863	6057
68" Height	4805	5050	5310	5446	5692	5883
64" Height	4667	4910	5167	5301	5544	5732
62 3/4" Height	4635	4877	5134	5267	5510	5696
57 3/4" Height	4374	4610	4862	4994	5230	5414
56" Height	4288	4522	4770	4902	5135	5317
WIDTH A+B	84"	90"	96"	102"	108"	114"

* Return panel is 3/8" glass

G-CS-1648 and G-CS-1648-B • 1/4" Glass*

80" Height	4950	5135	5290	5562	5761	6018
76" Height	4816	4999	5152	5421	5618	5872
72" Height	4683	4862	5014	5280	5474	5726
70 3/4" Height	4636	4814	4965	5228	5420	5669
68" Height	4532	4708	4859	5119	5310	5556
66" Height	4474	4649	4799	5059	5249	5494
WIDTH A+B	72"	78"	84"	90"	96"	102"

* Return panel is 3/8" glass

G-CT-636 and G-CT-636-B • 3/8" Glass

72" Height	5437	5688	5954	6135	6387	6624
68" Height	5264	5509	5769	5947	6193	6425
64" Height	5106	5349	5605	5779	6022	6249
62 3/4" Height	5063	5306	5563	5734	5976	6201
57 3/4" Height	4756	4992	5243	5411	5648	5867
56" Height	4650	4884	5132	5298	5532	5749
WIDTH A+B	84"	90"	96"	102"	108"	114"

G-CS-1648 and G-CS-1648-B • 3/8" Glass

80" Height	5521	5760	5943	6217	6445	6705
76" Height	5372	5606	5786	6057	6281	6538
72" Height	5223	5452	5629	5897	6117	6372
70 3/4" Height	5074	5298	5472	5737	5954	6205
68" Height	5019	5240	5413	5676	5890	6138
66" Height	4842	5057	5228	5487	5698	5943
WIDTH A+B	72"	78"	84"	90"	96"	102"

ALUMINUM PIVOT HINGE DOORS

STANDARD FEATURES ON GAP/GAPW MODELS

- Aluminum pivot hinges
- Aluminum round designer header and base where indicated (not required on GAPW models)
- Frameless 3/8" Clear glass with 90 degree edges
- **Standard Finishes:** Silver Anodized Aluminum; Gold Anodized Aluminum
- 6" C-Pull handle

AVAILABLE UPGRADES FOR GAP/GAPW MODELS

Please see the red pages in the back of this catalog for upgrade information and pricing

Glass Upgrades Available:

(see page 18 for pricing, clear glass standard)

Antique	Bisselux	Bronze Tint	Bubble
Grey Tint	Rain	Starphire	Aquatic
Cascade	Mist	Vertical Wave	Glue Chip

GeoGlass available on model 70 only

Diamon Fusion Protective Coating - \$7 per sq ft

1/2" Glass Upgrade NOT Available

Mitered Glass Option Available - 15° Miter:

(90 degree glass standard)

Mitered Glass provides a cleaner look, giving the appearance of one piece of glass. It is available on all GAP / GAPW models except GAP1629 and GAPW-1629.

Model	Add to List
70	\$125
1627	\$250
1628	\$500
1631	\$500
1632	\$750

Metal Finish Upgrades Available:

(standard finishes listed above)

Satin Nickel, Satin Chrome - \$50 per door/panel
 Colortec Paint - \$150 per door/panel
 Custom Paint - \$350 setup + \$150 per door/panel

Hardware Upgrades Available:

(6" C-Pull handle standard, see page 16)

6" Circle - \$85	8" C-Pull - \$90
6" Spindle - \$80	8" Spindle - \$100
6" Bow - \$80	8" Bow - \$100
6" Molded - \$100	8" Molded - \$125
6" Highline Round - \$150	6" Highline Flat - \$150

★ Some sizes are available in Glasstec **Quick Ship Program** providing lower pricing & quicker delivery. See page 19 for details.

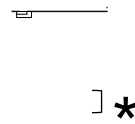

GAP-70
Single Door with Header



GAPW-70
Single Door without Header

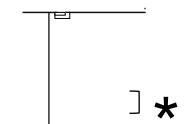

GAP-1627
Door & Panel, with Header

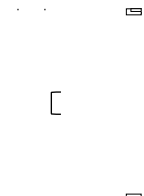

GAPW-1627
Door & Panel without Header

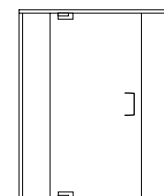

GAP-1628
Panel, Door, Panel with Header



GAP-1629
French Doors with Header

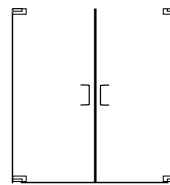

GAPW-1629
French Doors without Header

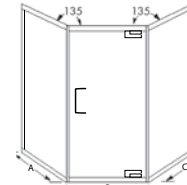

GAP-1669
Neo-Angle with Header

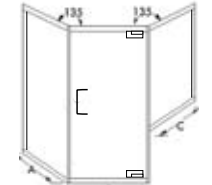

GAP-1669-B
Neo-Angle with Buttress Panel and Header

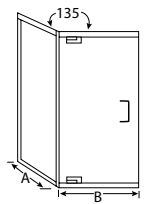

GAP-1669 2/3
Two-Thirds Neo-Angle with Header

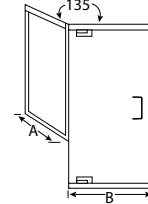

GAP-1669 2/3-B
Two-Thirds Neo-Angle with Buttress Return and Header

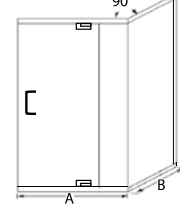

GAP-1631
Corner Enclosure with Header

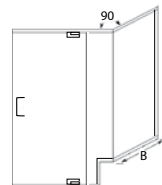

GAP-1631-B
Corner Enclosure with Buttress Return and Header

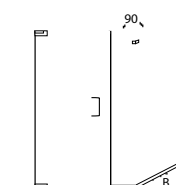

GAPW-1631
Corner Enclosure without Header, with corner clip

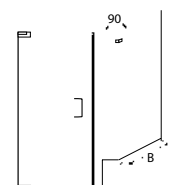

GAPW-1631-B
Corner Enclosure with Buttress Return, without Header, with corner clip

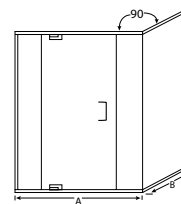

GAP-1632
Panel, Door, Panel Corner Enclosure with Header

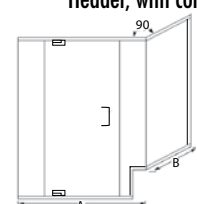

GAP-1632-B
Panel, Door, Panel Corner Enclosure with Buttress Return and Header

ALUMINUM PIVOT HINGE DOORS



GAP Pivot Hinge
Mounts to Header

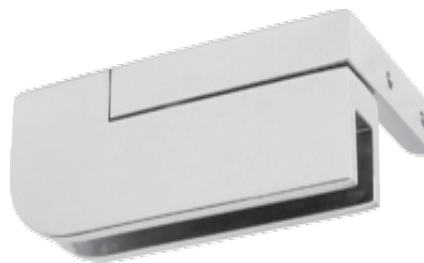

GAPW Pivot Hinge
Mounts to Wall

Wall mount hinges must attach to a wall that does not exceed 3/16" out of plumb from top hinge to bottom hinge.

Largest door 30" x 76", 3/8" glass, maximum of 45 lbs. per hinge.

Non Header units with return panel requires a corner clip

Standard Finishes:

Silver Anodized Aluminum
Gold Anodized Aluminum

Standard Glass:

3/8" Clear - 90° Edges
1/2" Glass Not Available

GAP-70 & GAPW-70

84" Height	1245	1279	1312	*1345	*1378
80" Height	1223	1255	1287	*1319	*1350
76" Height	1201	1231	1261	1292	*1322
72" Height	1139	1168	1197	1226	*1255
WIDTH	24"	26"	28"	30"	32"

GAP-1669 & GAP-1669-B

84" Height	2913	3018	3122	3226	3331	3435	3539
80" Height	2780	2885	2989	3093	3197	3302	3406
76" Height	2648	2752	2857	2961	3065	3169	3274
72" Height	2516	2620	2724	2829	2933	3037	3142
WIDTH A+B+C	60"	66"	72"	78"	84"	90"	96"

GAP-1627 & GAPW-1627

84" Height	1687	1789	1892	1994	2097	2215	2317
80" Height	1646	1744	1842	1940	2039	2152	2251
76" Height	1584	1678	1772	1866	1960	2069	2163
72" Height	1498	1588	1678	1767	1857	1962	2052
WIDTH	36"	42"	48"	54"	60"	66"	72"

Additional width may require header for GAPW units

GAP-1669-2/3 & GAPW-1669-2/3-B

84" Height	2127	2229	2332	2434	2537	2638
80" Height	2038	2141	2243	2346	2448	2551
76" Height	1951	2053	2156	2258	2361	2463
72" Height	1863	1966	2068	2170	2272	2375
WIDTH A+B	36"	42"	48"	54"	60"	66"

GAP-1628

84" Height	2054	2124	2256	2326	2458	2528	2660
80" Height	1981	2048	2175	2241	2369	2435	2562
76" Height	1909	1973	2095	2159	2280	2344	2466
72" Height	1862	1923	2039	2100	2217	2278	2394
WIDTH	48"	54"	60"	66"	72"	78"	84"

GAP-1631 & GAP-1631-B

GAPW-1631 & GAPW-1631-B

84" Height	2578	2682	2786	2890	2994	3098	3202
80" Height	2466	2570	2674	2778	2882	2986	3090
76" Height	2352	2456	2560	2664	2768	2872	2976
72" Height	2240	2344	2448	2552	2656	2760	2864
WIDTH A+B	66"	72"	78"	84"	90"	96"	102"

Additional width may require header for GAPW units

GAP-1629 & GAPW-1629

84" Height	2097	2208	2320	2432	2543	*2655
80" Height	2035	2147	2259	2370	2482	*2593
76" Height	1973	2085	2197	2308	2420	2532
72" Height	1912	2023	2135	2247	2358	2470
WIDTH	30"	36"	42"	48"	54"	60"

* GAP only. Not available on GAPW - weight restrictions

GAP-1632 & GAP-1632-B

84" Height	2877	2980	3083	3187	3290	3392	3495
80" Height	2733	2836	2940	3043	3146	3250	3353
76" Height	2590	2694	2797	2900	3004	3106	3209
72" Height	2447	2550	2653	2754	2860	2963	3067
WIDTH A+B	72"	78"	84"	90"	96"	102"	108"

Notched panels, add \$250 to prices listed above

BRASS PIVOT HINGE DOORS

STANDARD FEATURES ON GP/GPW MODELS

- Solid Brass pivot hinges
- Solid Brass round designer header and base where indicated (not required on GPW models)
- Frameless 3/8" Clear glass with 90 degree edges
- **Standard Finishes:** Polished Chrome; Satin Chrome; Polished Nickel; Satin Nickel
- 6" C-Pull handle

AVAILABLE UPGRADES FOR GP/GPW MODELS

Please see the red pages in the back of this catalog for upgrade information and pricing

Glass Upgrades Available:

(see page 18 for pricing, clear glass standard)

Antique	Bisselux	Bronze Tint	Bubble
Grey Tint	Rain	Starphire	Aquatic
Cascade	Mist	Vertical Wave	Glue Chip

GeoGlass available on model 70 only

Diamon Fusion Protective Coating - \$7 per sq ft

1/2" Glass Upgrade Available:

1/2" glass available on all GP/GPW models (3/8" clear glass is standard). 1/2" Clear glass - add \$12 per sq ft. See page 18 for additional pricing.

Mitered Glass Option

Available - 15° Miter:

(90 degree glass standard)

Mitered Glass provides a cleaner look, giving the appearance of one piece of glass. It is available on all GP/GPW models except GP1629 and GPW-1629.

Model	Add to List
70	\$125
1627	\$250
1628	\$500
1631	\$500
1632	\$750

Metal Finish Upgrades Available:

(standard finishes listed above)

Colortec Paint - \$150 per door/panel
 Custom Paint - \$350 setup + \$150 per door/panel
 Antique Brass, Brushed Bronze & 24K Gold - call factory

Hardware Upgrades Available:

(6" C-Pull handle standard, see page 16)

6" Circle - \$85	8" C-Pull - \$90
6" Spindle - \$80	8" Spindle - \$100
6" Bow - \$80	8" Bow - \$100
6" Molded - \$100	8" Molded - \$125
6" Highline Round - \$150	6" Highline Flat - \$150

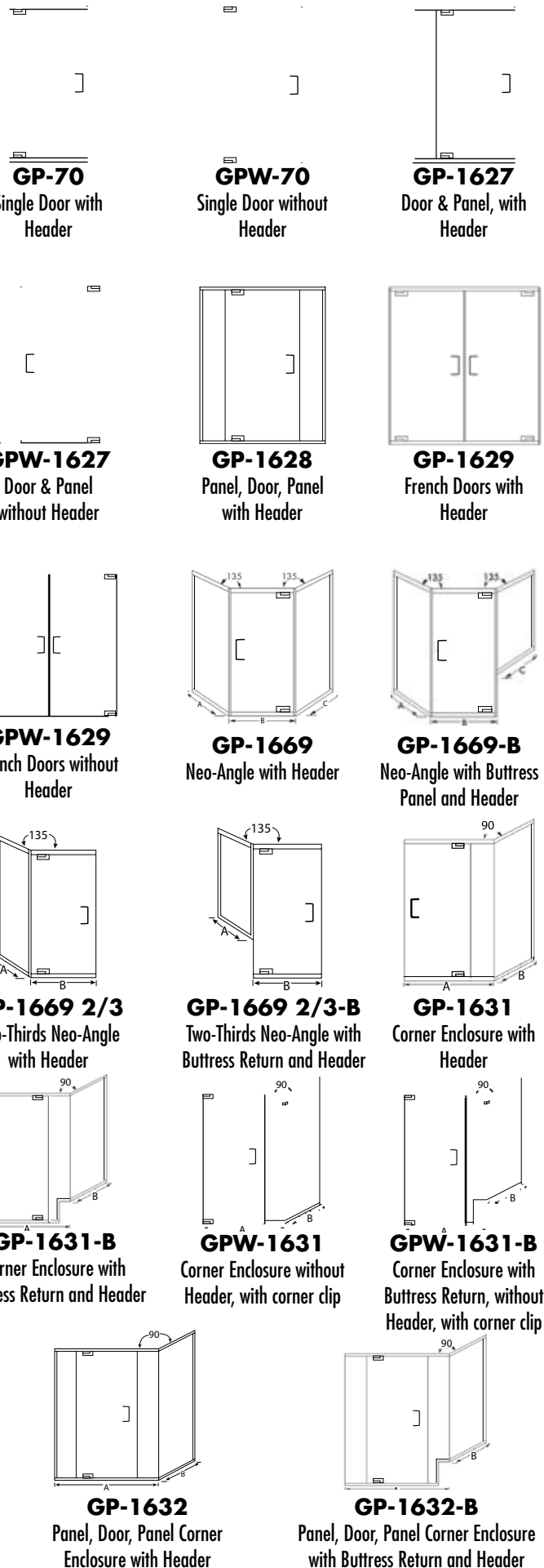

BRASS PIVOT HINGE DOORS



GP Pivot Hinge
Mounts to Header

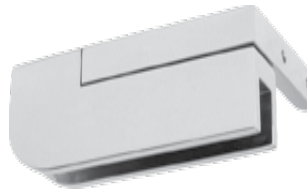

GPW Pivot Hinge
Mounts to Wall

Wall mount hinges must attach to a wall that does not exceed 3/16" out of plumb from top hinge to bottom hinge.

Largest door 30" x 76", 3/8" glass, maximum of 45 lbs. per hinge.

Standard Finishes:

Polished Chrome
Polished Nickel

Satin Chrome
Satin Nickel

Standard Glass: 3/8" Clear - 90° Edges

Non Header units with return panel requires a corner clip

GP-70 & GPW-70

92" Height	1813	1874	1934	*1994	*2055	*2131
88" Height	1793	1852	1911	*1970	*2030	*2104
84" Height	1760	1831	1889	*1946	*2004	*2077
80" Height	1740	1796	1853	*1909	*1966	*2037
76" Height	1720	1775	1830	1885	*1940	*2010
72" Height	1700	1754	1807	1861	*1914	*1983
WIDTH	24"	26"	28"	30"	32"	34"

GP-1627 & GPW-1627

92" Height	2691	2899	3107	3315	3523	3745	3953
88" Height	2645	2849	3054	3258	3462	3680	3885
84" Height	2599	2800	3000	3201	3401	3616	3816
80" Height	2529	2726	2923	3119	3316	3526	3723
76" Height	2484	2676	2869	3062	3255	3461	3654
72" Height	2438	2626	2816	3005	3194	3397	3585
WIDTH	36"	42"	48"	54"	60"	66"	72"

Additional width may require header for GPW units

GP-1628

92" Height	4061	4231	4468	4638	4874	5044	5281
88" Height	3982	4150	4381	4548	4779	4946	5177
84" Height	3903	4068	4293	4458	4683	4848	5073
80" Height	3798	3960	4180	4344	4562	4724	4944
76" Height	3719	3878	4093	4252	4467	4625	4840
72" Height	3640	3797	4006	4162	4371	4527	4736
WIDTH	48"	54"	60"	66"	72"	78"	84"

GP-1629 & GPW-1629

92" Height	2897	3045	3260	3408	3622	*3771
88" Height	2867	3014	3222	3368	3577	*3723
84" Height	2838	2982	3185	3328	3531	*3675
80" Height	2809	2950	3147	3288	3486	*3626
76" Height	2780	2918	3110	3248	3440	3578
72" Height	2751	2886	3073	3208	3395	3530
WIDTH	30"	36"	42"	48"	54"	60"

* GP only. Not available on GPW. - weight restrictions

GP-1669 & GP-1669-B

92" Height	4850	5048	5277	5474	5735	5932	6193
88" Height	4745	4940	5163	5358	5613	5808	6063
84" Height	4640	4832	5050	5242	5492	5684	5934
80" Height	4484	4698	4910	5100	5344	5534	5778
76" Height	4379	4566	4773	4959	5198	5385	5624
72" Height	4274	4458	4659	4843	5076	5260	5494
WTH A+B +C	60"	66"	72"	78"	84"	90"	96"

GP-1669-2/3 & GPW-1669-2/3-B

92" Height	3223	3446	3642	3865	4061	4284
88" Height	3161	3380	3572	3791	3983	4201
84" Height	3100	3314	3502	3717	3905	4119
80" Height	3012	3222	3406	3616	3801	4011
76" Height	2926	3132	3312	3518	3698	3904
72" Height	2864	3066	3242	3444	3620	3822
WIDTH A+B	36"	42"	48"	54"	60"	66"

GP-1631 & GP-1631-B

GPW-1631 & GPW-1631-B

92" Height	4505	4708	4873	5113	5296	5480	5682
88" Height	4416	4614	4776	5012	5191	5370	5569
84" Height	4326	4521	4679	4910	5086	5261	5456
80" Height	4211	4402	4555	4783	4954	5125	5316
76" Height	4122	4309	4458	4682	4849	5016	5203
72" Height	4033	4215	4361	4581	4744	4907	5089
WIDTH A+B	66"	72"	78"	84"	90"	96"	102"

Additional width may require header for GPW units

GP-1632 & GP-1632-B

92" Height	4756	4963	5136	5357	5597	5803	5976
88" Height	4658	4860	5030	5248	5482	5684	5854
84" Height	4559	4757	4925	5138	5367	5565	5732
80" Height	4408	4602	4767	4976	5199	5393	5558
76" Height	4401	4591	4754	4958	5176	5366	5528
72" Height	4303	4489	4648	4849	5061	5247	5406
WIDTH A+B	72"	78"	84"	90"	96"	102"	108"

Notched panels, add \$250 to prices listed above

BRASS WALL MOUNT HINGE DOORS

STANDARD FEATURES ON GW MODELS

- Solid Brass wall mounted hinges - dual acting
- Extruded Aluminum or Brass wall channel for stationary panel(s) where indicated
- Frameless 3/8" Clear glass with 90 degree edges
- Standard 24" door width on Door/Panel and Corner Enclosure models
- **Aluminum Standard Finishes:** Silver Anodized Aluminum; Gold Anodized Aluminum
- **Solid Brass Standard Finishes:** Polished Chrome; Satin Chrome; Polished Nickel; Satin Nickel
- 6" C-Pull handle

AVAILABLE UPGRADES FOR GW MODELS

Please see the red pages in the back of this catalog for upgrade information and pricing

Glass Upgrades Available:

(see page 18 for pricing, clear glass standard)

Antique	Bisselux	Bronze Tint	Bubble
Grey Tint	Rain	Starphire	Aquatic
Cascade	Mist	Vertical Wave	Glue Chip

GeoGlass available on model 70 only

Diamon Fusion Protective Coating - \$7 per sq ft

1/2" Glass Upgrade Available:

1/2" glass available on all GW models (3/8" clear glass is standard). Due to overall bow and warp tolerances, we recommend 1/2" glass for all units 84" and above. 1/2" Clear glass - add \$12 per sq ft. See page 18 for additional pricing.

Mitered Glass NOT Available:

Mitered Glass is not available on GW models due to dual acting hinge

Metal Finish Upgrades Available:

(standard finishes listed above)

Satin Chrome / Nickel Aluminum - \$50 per door/panel
 Colortec Paint - \$150 per door/panel
 Custom Paint - \$350 setup + \$150 per door/panel
 Antique Brass, Brushed Bronze & 24K Gold - call factory

Hardware Upgrades Available:

(6" C-Pull handle standard, see page 16)

6" Circle - \$85	8" C-Pull - \$90
6" Spindle - \$80	8" Spindle - \$100
6" Bow - \$80	8" Bow - \$100
6" Molded - \$100	8" Molded - \$125
6" Highline Round - \$150	6" Highline Flat - \$150

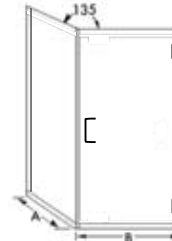

GW-1669-2/3
Two-Thirds Neo-Angle with Wall Channel

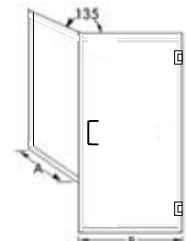

GW-1669-2/3-B
Two-Thirds Neo-Angle with Buttress Panel and Wall Channel

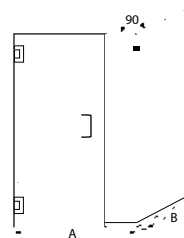

GW-1631
Corner Enclosure with Wall Channel and Corner Clip (see clip pricing, pg 17)

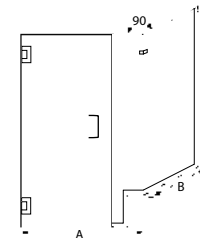

GW-1631-B
Corner Enclosure with Buttress Return, Wall Channel & Corner Clip

GW models with panels - Openings up to 48" do not require a header. Over 48", a header is recommended. Add to list price: Aluminum Header - \$10 per ft. Brass Header - \$80 per ft.

Standard units are made without a threshold. Depending on base condition, slope, and water contact with door, a full bottom track may be necessary to prevent leakage. You MUST specify if needed.



WARNING: It is not recommended to hang a door that exceeds 80 lbs. or 28" with two wall mounted hinges. We recommend three. Please see Weight Data below.

Weight Data:	lbs.
3/8" Glass	5.0 lbs/sq. ft.
1/2" Glass	6.5 lbs/sq. ft.
Example: 24" x 72" Door, 3/8" Glass	
24 x 72 = 1728 ÷ 144 = 12 sq ft x 5 = 60 lbs.	

* Some sizes are available in Glasstec **Quick Ship Program** providing lower pricing and quicker delivery. See page 19 for details

BRASS WALL MOUNT HINGE DOORS



**GW Wall
Mount
Hinge**

**Standard
Glass:**

3/8" Clear - 90° Edges

Aluminum Standard Finishes:

Silver Anodized Aluminum Gold Anodized Aluminum

Solid Brass Standard Finishes:

Polished Chrome Satin Chrome
Polished Nickel Satin Nickel

Optional Clips:

Clips may be used in place of wall channels. See page 17 for pricing.

Return panels without a header require a corner clip. See page 17 for pricing.

This hinge system is only as safe as the substructure it has been mounted to. Unlike the CENTURY pivot system, this hinge system has all the weight of the door on the wall.

It is your responsibility to establish the condition to which you are mounting the hinges and to select the proper fasteners.

GW-70					
84" Height	1296	1329	1555	*1588	*1621
80" Height	1258	1290	1322	*1546	*1578
76" Height	1235	1265	1296	*1326	*1548
72" Height	1185	1214	1242	*1271	*1300
WIDTH	24"	26"	28"	30"	32"

GW-1629						
84" Height	*2186	*2253	*2386	*2452	*2585	*3036
80" Height	2148	2211	2338	2402	2528	*2592
76" Height	2088	2148	2269	2330	2451	*2511
72" Height	2003	2060	2175	2233	2348	*2405
WIDTH	30"	36"	42"	48"	54"	60"

GW-1627 • Aluminum Wall Channel					
84" Height	1688	1789	1891	1992	2093
80" Height	1645	1742	1839	1936	2033
76" Height	1581	1673	1766	1858	1951
72" Height	1498	1580	1668	1756	1844
WIDTH	36"	42"	48"	54"	60"

GW-1627 • Solid Brass Wall Channel					
84" Height	2158	2284	2411	2537	2664
80" Height	2098	2220	2342	2464	2586
76" Height	2017	2135	2252	2370	2488
72" Height	1911	2024	2137	2250	2364
WIDTH	36"	42"	48"	54"	60"

GW-1669-2/3 & GW-1669-2/3-B Aluminum Wall Channel						
92" Height	2279	2389	2499	2610	2720	2830
88" Height	2229	2334	2440	2546	2652	2758
84" Height	1986	2087	2189	2290	2391	2493
80" Height	1907	2004	2101	2198	2295	2392
76" Height	1830	1923	2015	2108	2200	2293
72" Height	1780	1868	1956	2044	2132	2220
WIDTH A+B	42"	48"	54"	60"	66"	72"

GW-1669-2/3 & GW-1669-2/3-B Solid Brass Wall Channel						
92" Height	2782	2918	3054	3190	3326	3461
88" Height	2714	2846	2977	3109	3240	3372
84" Height	2455	2582	2709	2836	2963	3090
80" Height	2359	2482	2604	2727	2849	2972
76" Height	2265	2383	2501	2619	2737	2856
72" Height	2198	2311	2425	2539	2652	2766
WIDTH A+B	42"	48"	54"	60"	66"	72"

GW-1631 & GW1631-B Aluminum Wall Channel							
84" Height	2524	2626	2727	2847	2949	3053	3156
80" Height	2419	2516	2613	2729	2826	2925	3025
76" Height	2276	2369	2462	2573	2665	2760	2855
72" Height	2214	2302	2390	2497	2585	2675	2766
WIDTH A+B	66"	72"	78"	84"	90"	96"	102"

GW-1631 • Solid Brass Wall Channel							
84" Height	3116	3244	3371	3516	3644	3773	3903
80" Height	2994	3117	3240	3381	3504	3629	3754
76" Height	2835	2953	3071	3208	3326	3447	3567
72" Height	2755	2869	2983	3115	3229	3345	3461
WIDTH A+B	66"	72"	78"	84"	90"	96"	102"

* Three wall are required on doors exceeding 80 lbs. or 28" in width. Pricing includes third hinge where indicated.

Additional width may require header
Additional height - custom quote, please call factory

Notched panels, add \$250 to prices listed above

BRASS GLASS TO GLASS HINGE DOORS

STANDARD FEATURES ON GG MODELS

- Solid Brass glass to glass hinges - dual acting
- Extruded Aluminum or Brass wall channel for stationary panel(s) where indicated
- Frameless 3/8" Clear glass with 90 degree edges
- Standard 24" door width
- **Aluminum Standard Finishes:** Silver Anodized Aluminum; Gold Anodized Aluminum
- **Solid Brass Standard Finishes:** Polished Chrome; Satin Chrome; Polished Nickel; Satin Nickel
- 6" C-Pull handle

AVAILABLE UPGRADES FOR GG MODELS

Please see the red pages in the back of this catalog for upgrade information and pricing

Glass Upgrades Available:

(see page 18 for pricing, clear glass standard)

Antique	Bisselux	Bronze Tint	Bubble
Grey Tint	Rain	Starphire	Aquatic
Cascade	Mist	Vertical Wave	Glue Chip

GeoGlass not available on GG Models

Diamon Fusion Protective Coating - \$7 per sq ft

1/2" Glass Upgrade Available:

1/2" glass available on all GG models (3/8" clear glass is standard). 1/2" Clear glass - add \$12 per sq ft. See page 18 for additional pricing.

Mitered Glass NOT Available:

Mitered Glass is NOT available on GG models due to dual acting hinge

Metal Finish Upgrades Available:

(standard finishes listed above)

Satin Chrome / Nickel Aluminum - \$50 per door/panel

Colortec Paint - \$150 per door/panel

Custom Paint - \$350 setup + \$150 per door/panel

Antique Brass, Brushed Bronze & 24K Gold - call factory

Hardware Upgrades Available:

(6" C-Pull handle standard, see page 16)

6" Circle - \$85	8" C-Pull - \$90
6" Spindle - \$80	8" Spindle - \$100
6" Bow - \$80	8" Bow - \$100
6" Molded - \$100	8" Molded - \$125
6" Highline Round - \$150	6" Highline Flat - \$150

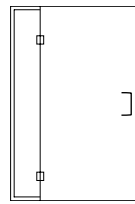

GG-1627
Full Height Door
& Panel with Wall
Channel

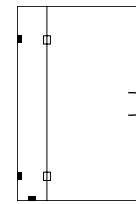

GG-1627
Door & Panel Open Above
with Wall Clips (see clip
pricing, pg 17)

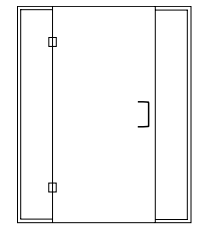

GG-1628
Full Height Panel, Door,
Panel with Wall Channel

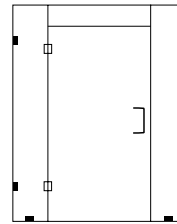

GG-1628
Panel, Door, Panel Open
Above with Wall Clips
(see clip pricing, pg 17)

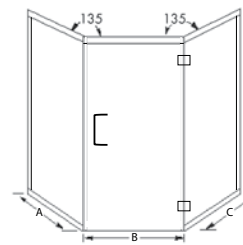

GG-1669
Neo-Angle with Header

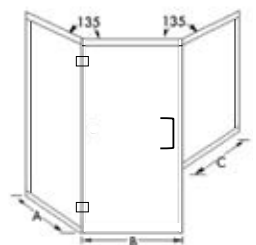

GG-1669-B
Neo-Angle with Buttress
Panel and Header

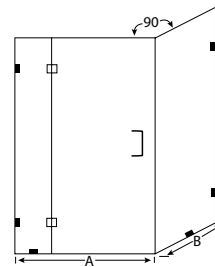

GG-1631
Corner Enclosure Open
Above with Wall Clips
(see clip pricing, pg 17)

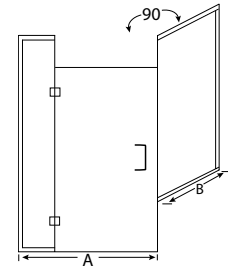

GG-1631-B
Corner Enclosure with Buttress
Return, Full Height Panels, and
Wall Channels

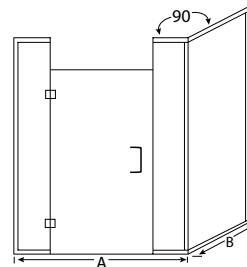

GG-1632
Corner Enclosure with
Full Height Panels and
Wall Channels

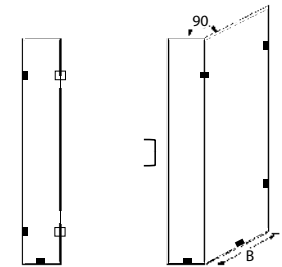

GG-1632
Corner Enclosure Open
Above with Corner and
Wall Clips
(see clip pricing, pg 17)

GG models - Openings up to 36" do not require a header. Over 36", a header is recommended or panels must run full height. To include header, add to list price:

Aluminum Header - \$10 per ft.

Brass Header - \$80 per ft.

Standard units are made without a threshold. Depending on base condition, slope, and water contact with door, a full bottom track may be necessary to prevent leakage. You MUST specify if needed.



BRASS GLASS TO GLASS HINGE DOORS

Aluminum Standard Finishes:

Silver Anodized Aluminum Gold Anodized Aluminum

Solid Brass Standard Finishes:

Polished Chrome Satin Chrome
Polished Nickel Satin Nickel



**GG Glass to
Glass Hinge**

**Standard
Glass:**

3/8" Clear
90° Edges

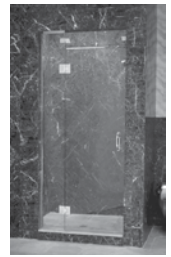

GG1627 • Aluminum Wall Channel

84" Height	1917	2014	2111	2209	2306	2419	2516
80" Height	1876	1969	2062	2155	2248	2356	2449
76" Height	1814	1903	1992	2080	2169	2273	2362
72" Height	1728	1813	1897	1982	2066	2166	2251
WIDTH	36"	42"	48"	54"	60"	66"	72"

GG-1628 • Aluminum Wall Channel

84" Height	2282	2348	2476	2542	2671	2737	2881
80" Height	2205	2268	2391	2454	2577	2640	2779
76" Height	2130	2190	2308	2368	2485	2545	2678
72" Height	2081	2138	2250	2307	2419	2476	2603
WIDTH	48"	54"	60"	66"	72"	78"	84"

GG-1669 & GG-1669-B Aluminum Wall Channel

84" Height	2843	2949	3052	3158	3643	3714	3819
80" Height	2749	2850	2949	3050	3183	3251	3352
76" Height	2656	2753	2848	2944	3072	3136	3233
72" Height	2588	2681	2772	2864	2986	3047	3140
WIDTH A+B+C	60"	66"	72"	78"	84"	90"	96"

GG-1631 & GG-1631-B Aluminum Wall Channel

92" Height	2851	2962	3072	3182	3292	3419	3529
88" Height	2788	2894	3000	3105	3211	3334	3439
84" Height	2725	2826	2928	3029	3130	3248	3349
80" Height	2633	2730	2827	2924	3021	3134	3231
76" Height	2543	2636	2728	2821	2913	3022	3114
72" Height	2480	2568	2656	2744	2832	2936	3024
WIDTH A+B	66"	72"	78"	84"	90"	96"	102"

GG-1632 & GG-1632-B Aluminum Wall Channel

84" Height	2967	3097	3162	3291	3388	3454	3583
80" Height	2844	2968	3030	3154	3247	3309	3433
76" Height	2775	2893	2953	3071	3159	3219	3337
72" Height	2604	2716	2773	2885	2969	3026	3138
WIDTH A+B	72"	78"	84"	90"	96"	102"	108"

GG1627 • Solid Brass Wall Channel

84" Height	2361	2491	2622	2752	2883	3029	3160
80" Height	2303	2430	2556	2682	2809	2950	3077
76" Height	2226	2348	2470	2592	2714	2851	2973
72" Height	2124	2242	2359	2477	2595	2728	2846
WIDTH	36"	42"	48"	54"	60"	66"	72"

GG-1628 • Solid Brass Wall Channel

84" Height	2943	3033	3187	3277	3431	3521	3690
80" Height	2845	2932	3080	3167	3316	3403	3566
76" Height	2749	2833	2975	3060	3202	3286	3444
72" Height	2678	2759	2896	2977	3114	3195	3347
WIDTH	48"	54"	60"	66"	72"	78"	84"

GG-1669 & GG-1669-B Solid Brass Wall Channel

92" Height	5080	5310	5895	6191	6421	6660	6956
88" Height	4978	5206	5440	5730	5957	6538	6828
84" Height	4877	5101	5331	5616	5840	6417	6701
80" Height	4748	4970	5195	5474	5695	5921	6200
76" Height	4621	4839	5061	5334	5552	5774	6047
72" Height	4519	4735	4952	5219	5435	5652	5919
WIDTH A+B+C	60"	66"	72"	78"	84"	90"	96"

GG-1631 & GG-1631-B Solid Brass Wall Channel

92" Height	3706	3836	3967	4097	4228	4374	4504
88" Height	3613	3739	3865	3991	4117	4259	4385
84" Height	3519	3641	3763	3885	4007	4144	4266
80" Height	3398	3516	3634	3751	3869	4002	4119
76" Height	3279	3392	3506	3619	3732	3861	3975
72" Height	3186	3295	3404	3513	3622	3746	3855
WIDTH A+B	66"	72"	78"	84"	90"	96"	102"

GG-1632 & GG-1632-B Solid Brass Wall Channel

84" Height	3881	4035	4125	4279	4401	4491	4645
80" Height	3725	3873	3961	4109	4226	4313	4461
76" Height	3624	3766	3850	3993	4106	4190	4333
72" Height	3420	3556	3638	3774	3883	3965	4101
WIDTH A+B	72"	78"	84"	90"	96"	102"	108"

* Three hinges are required on doors exceeding 80 lbs. or 28" in width. See Weight Data on page 8. Call for pricing.

Notched panels, add \$250 to prices listed above

JAMB MOUNT DOOR / SPRAY PANELS

GWS-70 - JAMB MOUNT BRASS HINGE DOORS

- Two Solid Brass out swing, jamb mount hinges
- Extruded Aluminum jambs
- Continuous hinge & striker jamb for a watertight seal or steam enclosure
- Clear poly carbonate drip cap seals the bottom
- 10 degree positive closure; self closing from 20 degrees
- Frameless 3/8" Clear glass with 90 degree edges
- 6" C-Pull handle

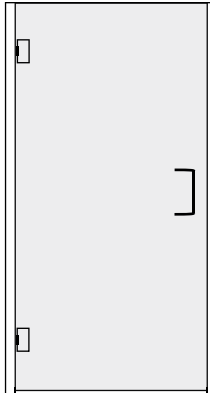

GWS-70 • Aluminum Channel Silver Anodized • Gold Anodized				
84" Height	1883	1917	1950	1983
80" Height	1861	1893	1925	1957
76" Height	1839	1869	1899	1930
72" Height	1777	1806	1835	1864
WIDTH	24"	26"	28"	30"
Satin Nickel Aluminum finish - Add \$275				
Oil Rubbed Bronze Paint on Aluminum - Add \$500				

GWS-100 - HINGED SPRAY PANEL

- Two Solid Brass dual swing, wall mount hinges
- 30" width x 60" height - standard size
- Frameless 3/8" Clear glass
- 10 degree radius corner
- Clear poly carbonate drip cap seals the bottom
- **Standard Finishes:** Polished Chrome; Satin Chrome; Polished Nickel; Satin Nickel
- Polished Brass, Satin Brass - add 20%; 24K Gold, Antique Brass, Oil Rubbed Bronze - call for quote
- Custom glass sizes and options available... call for quote

Without Pull Knob	With Pull Knob
800	850



GSP-100 - STATIONARY SPRAY PANEL

- Frameless 3/8" Clear 90 degree glass
- Extruded aluminum or brass wall channels for two sided mount
- 3 and 4 sided mount - call for pricing
- We recommend soffit channel for panels over 36" wide - consult factory for pricing

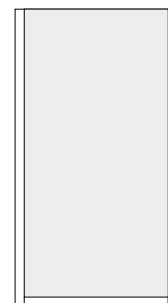

GSP-100 • Aluminum Channel Silver Anodized • Gold Anodized					
72" Height	548	628	726	823	920
68" Height	538	593	693	785	877
64" Height	528	583	661	747	834
60" Height	518	573	628	709	791
56" Height	508	563	618	673	747
WIDTH	24"	30"	36"	42"	48"
Satin Nickel; Satin Chrome Aluminum finish - Add \$35					
Colortec Paint - Add \$150			Custom Paint Match -Add \$450		

GSP-100 • Solid Brass Channel Polished or Satin Chrome • Polished or Satin Nickel					
72" Height	891	982	1073	1163	1254
68" Height	871	956	1042	1128	1214
64" Height	850	931	1012	1093	1174
60" Height	830	906	982	1057	1133
56" Height	810	881	951	1022	1093
WIDTH	24"	30"	36"	42"	48"
Colortec Paint - Add \$150			Custom Paint Match -Add \$450		
Antique Brass; Oil Rubbed Bronze; 24K Gold - Call for pricing					

ORDERING METHOD

Select the model number which identifies the enclosure type. Next, select the desired metal finish, glass style, glass thickness, and hardware. For best results, Century recommends completing the appropriate measuring guide to report accurate dimensions.

Examples:

Model Number	Metal Finish	Glass	Glass Thickness	Hardware
G-CT-636-B	AB	ER	1/4"	Bow Towel Bar
Solid brass sliding corner tub enclosure with buttress return; antique brass finish; 1/4" reed glass; bow towel bar				
GAP-1628	SL	RN	3/8"	6" Spindle
Aluminum pivot hinge panel, door, panel; silver anodized aluminum finish; 3/8" thick rain glass; 6" spindle handle				
GPW-1631	CM	CS	1/2"	6" Molded
Brass pivot wall mount hinge corner enclosure; custom color match finish; 1/2" cascade glass; 6" molded handle				
GW-1629	OB	ST	3/8"	8" C-Pull
Brass wall mount hinge french doors; oil rubbed bronze finish; 3/8" starphire glass; 8" c-pull handle				

Model Numbers	Solid Brass Finishes	Colortec Paint Colors	Glass Options
70 Single Door	PC Polished Chrome	PW Pearl White	CL Clear
1627 Door & Panel	SC Satin Chrome	LW Linen White	BU Bubble
1628 Panel, Door, Panel	PN Polished Nickel	RR Royal Red	AT Antique
1629 French Doors	SN Satin Nickel	BT Bronze Tone	BT Bronze Tint
1669 Neo-Angle	PB Polished Brass	AT Almond Tone	GT Grey Tint
1669 2/3 2/3 Neo-Angle	SB Satin Brass	PG Platinum Grey	RN Rain
1631 Door & Panel with 90 degree Return Panel	AB Antique Brass	TG Teal Green	ST Starphire
1632 Panel, Door, Panel with 90 degree Return Panel	OB Oil Rubbed Bronze	DR Dusty Rose	GC Glue Chip
B Buttress	24 24K Gold	OR Oil Rubbed Bronze	GB Bisselux
	Aluminum Finishes	CC Cameo Cream	AU Aquatic
	SL Silver Anodized Aluminum	PO Powder Grey	CD Cascade
	GD Gold Anodized	CB Cobalt Blue	MI Mist
	SN Satin Nickel	CA Caramel	GE GeoGlass
	SC Satin Chrome Anodized	BK Black	WA Vertical Wave
		BS Biscuit	PS Pattern 62
Hinges		Custom Paint Match	ER Reed
GAP Aluminum Pivot		CM Color Match	
GAPW Aluminum Wall Mount Pivot			
GP Brass Pivot			
GPW Brass Wall Mount Pivot			
GW Brass Wall Mount			
GG Brass Glass to Glass			

Measuring Guides and Order Forms are available for ease of ordering. Please ask your Customer Service Representative should you need more.

STEAM VENTS

Steam Vents are available on all frameless hinged models when full floor to ceiling glass is being utilized.

GCWWV - Glasstec Clamp Wall to Wall Vent

- Solid Brass clamp hinges
- Maximum width 30", maximum height 12"
- 3/4" finger pull standard
- Standard finishes: Polished Chrome, Satin Chrome, Polished Nickel, Satin Nickel
- Upgrade finishes: add as additional panel when calculating upgrade finish price



Wall to Wall

3/8" Glass	1/2" Glass
420	480

GCGWV - Glasstec Clamp Glass to Wall Vent

- Solid Brass clamp hinges
- 24" maximum width x 12" maximum height
- Must attach to a minimum 6" panel
- 3/4" finger pull standard
- Standard finishes: Polished Chrome, Satin Chrome, Polished Nickel, Satin Nickel
- Upgrade finishes: add as additional panel when calculating upgrade finish price

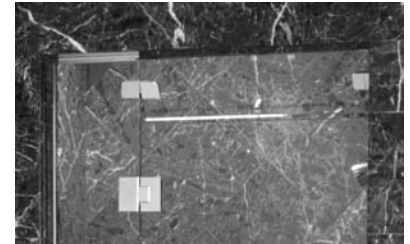

Glass to Wall

3/8" Glass	1/2" Glass
540	600

GCGGV - Glasstec Clamp Glass to Glass Vent

- Solid Brass clamp hinges
- 24" maximum width x 12" maximum height
- Must attach to a minimum 6" panel
- 3/4" finger pull standard
- Standard finishes: Polished Chrome, Satin Chrome, Polished Nickel, Satin Nickel
- Upgrade finishes: add as additional panel when calculating upgrade finish price



Glass to Glass

	3/8" Glass	1/2" Glass
In-Line 180°	680	740
Neo - 135°	780	840

GCEV - Glasstec Clamp Edge Vent

- Solid Brass clamp hinges
- 12" maximum width x 8" maximum height
- Main panel must have 6" of glass on each side of vent
- 3/4" finger pull standard
- Standard finishes: Polished Chrome, Satin Chrome, Polished Nickel, Satin Nickel
- Upgrade finishes: add as additional panel when calculating upgrade finish price

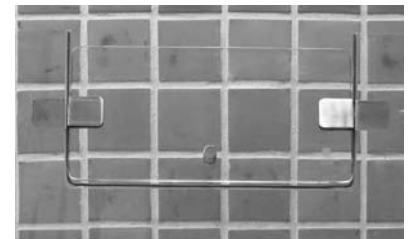

Edge

3/8" Glass	1/2" Glass
895	1025

Recommended for stationary panels

STEAM VENTS & STATIONARY TRANSOM

Steam Vents are available on all frameless hinged models when full floor to ceiling glass is being utilized.

GCIV - Glasstec Clamp Interior Vent

- Solid Brass clamp hinges
- 12" maximum width x 8" maximum height
- Main panel must have 6" of glass on each side of vent
- 3/4" finger pull standard
- Standard finishes: Polished Chrome, Satin Chrome, Polished Nickel, Satin Nickel
- Upgrade finishes: add as additional panel when calculating upgrade finish price

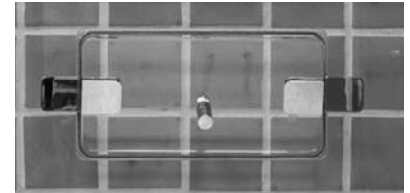

Interior

3/8" Glass	1/2" Glass
1100	1275

Recommended for stationary panels

GPV - Glasstec Pivot Vent

- Solid Brass pivot hinges
- 30" maximum width x 20" maximum height
- Full header above and below pivot vent
- Standard finishes: Polished Chrome, Satin Chrome, Polished Nickel, Satin Nickel
- Upgrade finishes: add as additional panel when calculating upgrade finish price



Pivot

3/8" Glass	1/2" Glass
525	650

GST-98 - Stationary Transom

- Standard aluminum finishes: Silver Anodized Aluminum, Gold Anodized Aluminum
- Standard brass finishes: Polished Chrome, Satin Chrome, Polished Nickel, Satin Nickel
- Upgrade finishes: add as additional panel when calculating upgrade finish price
- Transoms hitting at angle, add \$1.50 per inch miter charge
- Vertical channels optional, please specify

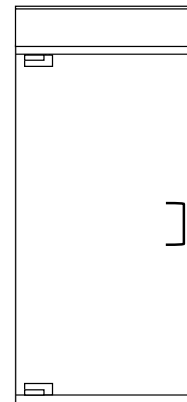

Stationary
Transom
above GP-70

Aluminum Channels - 3/8" Clear		
24" Height	325	525
12" Height	200	400
WIDTH	30"	60"

Brass Channels - 3/8" Clear		
24" Height	675	1100
12" Height	500	850
WIDTH	30"	60"

UPGRADES

OPTIONS AVAILABLE ONLY AS INDICATED ON PRODUCT PAGE

Finishes

Finishes for Headers, Wall Channels, and Hardware

*Colortec Paint Colors

(see glasstec brochure for samples)

- Pearl White
- Platinum Grey
- Powder Grey
- Linen White
- Teal Green
- Cobalt Blue
- Royal Red
- Dusty Rose
- Caramel
- Bronze Tone
- Oil Rubbed Bronze
- Black
- Almond Tone
- Cameo Cream
- Biscuit

	GCT/GCS	GAP/GAPW	GP/GPW	GW	GG
Silver Anodized Aluminum	N/A	Standard	N/A	Standard	Standard
Gold Anodized Aluminum	N/A	Standard	N/A	Standard	Standard
Satin Nickel Aluminum	N/A	\$50 per door or panel	N/A	\$50 per door or panel	\$50 per door or panel
Satin Chrome Aluminum	N/A		N/A		
Colortec Paint Colors*	\$150 per door or panel				
Custom Paint Match	\$350 set up and \$150 per door or panel				
Polished Chrome	Standard	N/A	Standard		
Satin Chrome	Standard	N/A	Standard		
Polished Nickel	Standard	N/A	Standard		
Satin Nickel	Standard	N/A	Standard		
Polished Brass	N/A	N/A	N/A	Brass Hinges Only Channels Anodized Aluminum	
Satin Brass	N/A	N/A	N/A		
Brushed Bronze	Custom →	N/A	Custom Quote... Call for Pricing		
Antique Brass	Custom →	N/A	Custom Quote... Call for Pricing		
24K Gold	Custom →	N/A	Custom Quote... Call for Pricing		

Decorative Handles

Please see product page for handle upgrades available on the model you are ordering.

Solid 6" c-pull standard for all Brass units. Tubular 6" c-pull standard for all Aluminum units.

Prices are added to unit price for upgrade. For hardware only prices, please call for quote

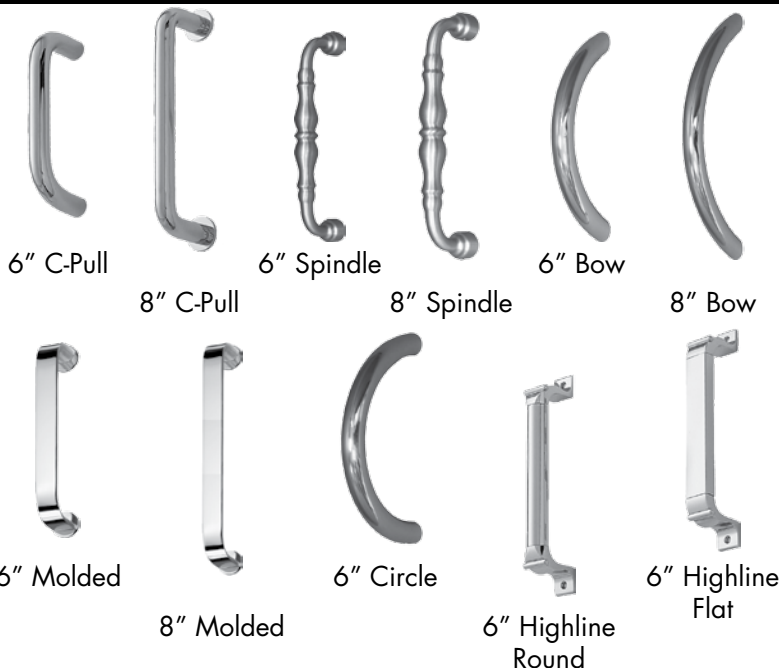

Decorative Handles

	6"	8"
C-Pull	Standard	\$90
Spindle	\$80	\$100
Bow	\$80	\$100
Circle	\$85	N/A
Molded	\$100	\$125
Highline Round	\$150	N/A
Highline Flat	\$150	N/A

Decorative Knobs

Please see product page for knob upgrades available on the model you are ordering

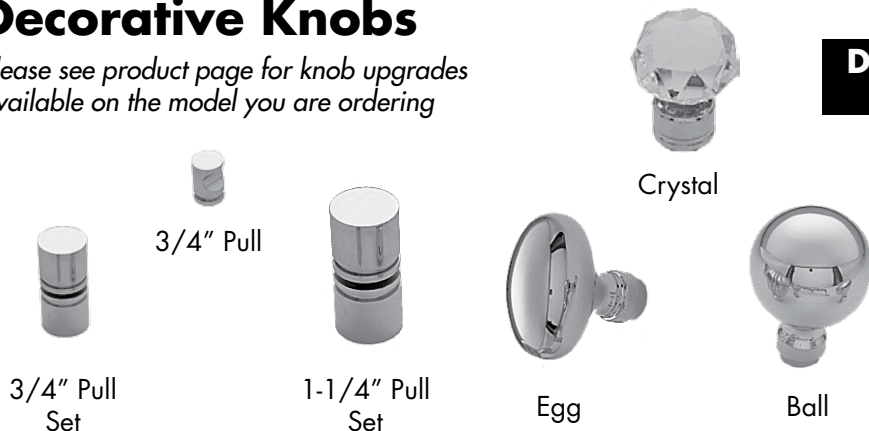

Decorative Knobs Bypass Doors Hinge Doors

3/4" Pull	N/C Option	N/A
3/4" Pull Set	N/A	\$25
1-1/4" Pull Set	N/A	\$50
Egg Knob	N/A	\$170
Ball Knob	N/A	\$180
Crystal Knob	N/A	\$225

UPGRADES

OPTIONS AVAILABLE ONLY AS INDICATED ON PRODUCT PAGE

Decorative Towel Bars

Please see product page for towel bar upgrades available on the model you are ordering



Modern



Traditional



Spindle



Bow



6" C-Pull Towel-Bar Combination
(Available for Hinge Doors ONLY)



Modern Back to Back
(Available for Hinge Doors ONLY)

Towel Bars

		Modern	Traditional	Spindle	Bow 18 & 24" Only	Modern Back to Back	6" C-Pull Towel Bar Combo
15"; 18"; 21"; 24"; 27"; 30"	Bypass	Std.	\$95	\$200	\$95	N/A	N/A
	Hinged Door	N/A	N/A	N/A	N/A	\$250	\$150
	Panel	\$125	\$185	\$300	\$125	\$250	N/A

Decorative Clips



Stationary Clip: Designed to secure a fixed panel to a wall, sill, or ceiling. 3/16" clearance between glass and wall for silicone. 3/4" x 1 1/4" hole notch required. Available for 3/8" and 1/2" glass. Add \$110 per clip.

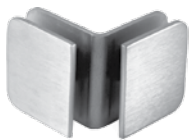

90 degree Corner Clip: Designed to secure two panels to create a 90 degree corner. Two 5/8" diameter holes required. Available in 90 degree or mitered, 3/8" or 1/2" glass.

90 degree glass edgework: add \$190 per clip.

Mitered glass edgework: add \$190 per clip plus \$3.00 per inch which covers both sides of the miter.



Neo Angle 135 Degree Clip: Designed to secure panels to create a 135 degree corner. Not available for special angles. Two 5/8" diameter holes required. Available for 3/8" or 1/2" glass. Add \$190 per clip.

Decorative clips are available for most models as an option to replace headers or wall channels. Corner clips are required for any return unit without a header.

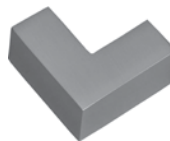

Top 90 Degree Corner Clip: Mounts directly on top of panels to secure a 90 degree corner. Does not require glass fabrication holes. Available in 90 degree or mitered, 3/8" or 1/2" glass.

90 degree glass edgework: add \$80 per clip.

Mitered glass edgework: add \$80 per clip plus \$2.70 per inch which covers both sides of the miter.

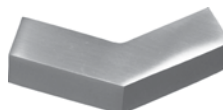

Top Neo Angle 135 Degree Clip: Mounts directly on top of panel to secure a 135 degree corner. Does not require glass fabrication hole. Available in 3/8" or 1/2" glass. Add \$95 per clip.

UPGRADES

OPTIONS AVAILABLE ONLY AS INDICATED ON PRODUCT PAGE

Decorative Glass *Please see product page for glass upgrades available on the model you are ordering*



Clear (Standard on All Models)



Bubble



Antique



Bronze Tint
Grey Tint

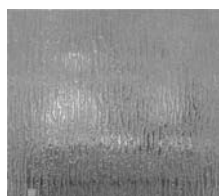

Rain



Starphire



Glue Chip

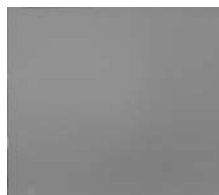

Bisselux

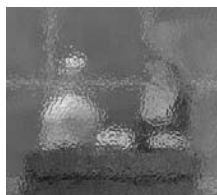

Aquatic



Cascade



Mist

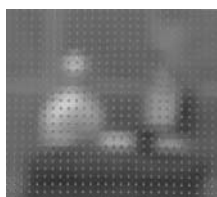

GeoGlass

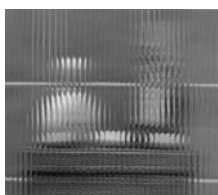

Vertical Wave



Pattern 62
(1/4" Glass only)

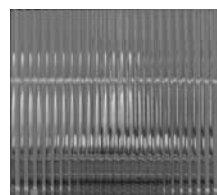

Reed
(1/4" Glass only)

Sliders: start with 1/4" base price then calculate sq. ft. (see formula). Glass price from grid below x total sq. ft. = glass up charge to base price. 1/4" & 3/8" ONLY.

Hinged Models: start with 3/8" base price then calculate Sq. Ft. (see formula). Glass price from grid below x total sq. ft. = glass up charge to base price. 3/8" & 1/2" ONLY.

1/2" Glass available on GP/GPW/GW/GG models as an upgrade to 3/8" clear glass. Not available on GAP and sliding door models.

Decorative Glass

	1/4"	3/8"	1/2"
Clear	std	std	\$12
Bubble	\$12	\$16	\$35
Antique	\$30	\$55	\$75
Bronze Tint	\$12	\$16	\$35
Grey Tint	\$12	\$16	\$35
Rain	\$12	\$16	\$35
Starphire	\$20	\$25	\$40
Glue Chip	\$25	\$35	N/A
Bisselux	\$25	\$45	\$65
Aquatic	\$25	\$30	N/A
Cascade	\$25	\$30	N/A
Mist	\$25	\$30	N/A
GeoGlass*	\$25	\$30	N/A
Vertical Wave	\$40	\$65	N/A
Pattern 62	\$12	N/A	N/A
Reed	\$16	N/A	N/A

* GeoGlass available on sliders and model 70 only

Formula for Square Feet:

Door Width in inches x Door Height in inches ÷ 144 = Square Feet

Example:

A door of 28" width and 80" height = 16 sf
 $28 \times 80 = 2240 \div 144 = 15.5555$ (round up to even number)

Mitered Glass provides a cleaner look, giving the appearance of one piece of glass. It is an upgrade available on some models as indicated on each product page. See pricing listed below.

Top View

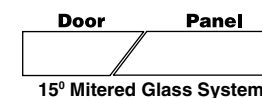
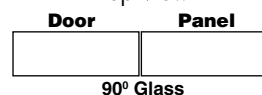

Model	Add to List
70	\$125
1627	\$250
1628	\$500
1631	\$500
1632	\$750

Diamon Fusion

Diamon Fusion bonds to glass to form an ultra-thin protective layer of optically clear durable material making the surface significantly easier to clean. It is available on all Century shower doors. Add \$7 per square foot.

GLASSTEC QUICK SHIP PROGRAM

Available on models, sizes, and finishes listed below using 3/8" Clear glass only. The Glasstec Quick Ship Program provides fast delivery and discounted prices on the most popular sizes in our Glasstec Line.

Actual measurements must conform as indicated on each model.

QGAP-70

- 3/8" Clear 90 degree glass only
- Aluminum top and bottom pivot hinges
- Round aluminum designer header & base
- 6" C-Pull handle
- Silver & Gold Anodized Aluminum finishes standard
- Pearl White - add 10%
- Satin Chrome, Satin Nickel - Add 15%
- Colortec Paint Colors - Add 20% / delivery increases to 3 weeks

QGAP-70 / 3/8" Clear Glass / Silver Anodized Aluminum • Gold Anodized Aluminum

Width Range	72" Height	76" Height
24 3/8" - 26 3/16"	755	775
26 3/16" - 28 1/2"	775	795
28 1/2" - 30 1/2"	795	815

Allowed out of square:

Width up to 1/4" on each wall
Height up to 1/8" for base

QGW-70

- 3/8" Clear 90 degree glass only
- Brass wall mount hinges
- 6" C-Pull handle
- Polished Chrome & Brass finishes standard
- Pearl White - add 10%
- Satin Chrome, Polished Nickel, Satin Nickel - Add 10%
- Oil Rubbed Bronze - add 20%

QGW-70 / 3/8" Clear Glass / Polished Chrome • Polished Brass

Width Range	70 7/8" Height	74 7/8" Height
24 1/4" - 26"	735	755
26" - 28 1/2"	755	775

Allowed out of square:

Width up to 3/16" on hinge side
up to 1/4" on handle side
Height up to 3/16"

QGAP-1627

- 3/8" Clear 90 degree glass only
- Aluminum top and bottom pivot hinges
- Round aluminum designer header & base
- Aluminum wall channels
- 6" C-Pull handle
- Silver & Gold Anodized Aluminum finishes standard
- Pearl White - add 10%
- Satin Chrome and Satin Nickel - Add 15%
- Colortec Paint Colors - Add 20% / delivery increases to 3 weeks

QGAP-1627 / 3/8" Clear Glass / Silver Anodized • Gold Anodized Aluminum

Width Range	72" Height	76" Height
30 3/16" - 36"	965	1065
36" - 42"	1031	1140
42" - 48"	1097	1215
48" - 54"	1163	1290
54" - 60"	1229	1440

Allowed out of square:

Width up to 1/4" on each wall
Height up to 1/8" for base

QGW-1627

- 3/8" Clear 90 degree glass only
- Brass wall mount hinges
- 6" C-Pull handle
- Aluminum wall channels (solid brass upgrade available)
- Chrome & Gold Anodized finishes standard
- Pearl White - add 10%
- Satin Chrome, Satin Nickel - Add 15%
- Polished Nickel (brass wall channels only) add \$40 per foot
- Colortec Paint Colors - Add 20% / delivery increases to 3 weeks

QGW-1627 / 3/8" Clear Glass / Polished Chrome • Polished Brass

Width Range	70 7/8" Height	74 7/8" Height
30 3/16" - 36"	945	1045
36" - 42"	1011	1120
42" - 48"	1077	1195
48" - 54"	1143	1270
54" - 60"	1209	1420

Allowed out of square:

Width up to 3/16" on hinge side
up to 7/16" on panel side
Height up to 1/8" for base

NOTES

Notched Panels

- Includes all notches within a panel
- ADD \$250 list to price



Undersized Panels

- Includes all panels under 6" wide (minimum width 5")
- Polished - \$5.50 per inch
- Mitered - \$6.50 per inch

Special Angles

- Includes all glass angle cuts other than standard:
15° - standard miter
22.5° - 135° Neo-angle
45° - 90° Corner
- Add \$350

Radius Corner up to 10"

- 3/8" Glass - ADD \$125 list to price
- 1/2" Glass - ADD \$175 list to price
- Over 10" - consult factory

Angled Panels

- Includes all panels with angle cut
- ADD \$500 list to price

Arch Top up to 30" Wide Door

- 3/8" Glass - ADD \$525 list to price
 - 1/2" Glass - ADD \$600 list to price
- Includes arch & polish to be added to regular priced Glasstec doors -
NOT QUICK SHIP

Angled Mount

- Includes units mounting to a wall on an angle
- ADD \$175 list to price

Per Inch Miter Charge

- Includes mitered glass on part of unit
- \$1.50 per inch

CONTACTS

CENTURY LOCATIONS

HEADQUARTERS

PETER NIGRO: VICE PRESIDENT OF SALES
West Paterson, NJ 07424

Phone: 973-785-4290 Fax: 973-785-0777

NEW JERSEY

250 Lackawanna Avenue
West Paterson, NJ 07424

Phone: 973-785-4290 800-524-2578
Fax: 973-785-0777

BRANCH LOCATIONS

ILLINOIS

830 W. Foster Avenue
Bensenville, IL 60106

Phone: 630-616-0120 Fax: 630-616-0121

MARYLAND

11890 Old Baltimore Pike
Beltsville, MD 20706

Phone: 301-937-1257 Fax: 301-937-1383

PENNSYLVANIA

(Robert Ellsworth & Associates, LLC)

815 Hylton Road, Suite #4
Pennsauken, NJ 09110

Phone: 856-488-9535 Fax: 856-488-9576

CENTURY SALES STAFF

NJ SOUTH OF RT. 195 , EASTERN PA

ROBERT ELLSWORTH & ASSOCIATES
Phone: 856-488-9535 Fax: 856-488-9576

NJ NORTH OF RT. 195, ROCKLAND COUNTY NY

BOB WHELAN
Phone: 973-617-7686 Fax: 973-328-7435

NY, STATEN ISLAND, BRONX, WESTCHESTER, PUTNAM

DICK DIXON
Phone: 631-367-1546 Fax: 631-367-1547

LONG ISLAND, BROOKLYN, QUEENS, MANHATTAN

KEVIN DEVERS
Phone/Fax: 631-878-5472

DE, MD, VA & DC

DAVID DIXON
Phone: 703-803-8385 Fax: 703-802-7986

NYS EAST OF SYRACUSE, WESTERN CT, WESTERN MA

CHRIS GERARDI
Phone: 518-573-4310 Fax: 413-442-3265

CENTURY SALES STAFF

METRO BOSTON, FAIRFIELD CT, CT

JOHN MAGRUDER
Phone: 781-383-2030 Fax: 781-383-0175

ME, NH, VT & NORTHEAST MA

PHIL ABBOTT
Phone: 603-731-0434 Fax: 603-228-3709

RI, S.E. MA, EASTERN CT

BRIAN PETERSON
Phone: 401-785-1296 Fax: 401-781-6755

EASTERN MA

MARK SORENSON
Phone: 603-498-3881 Fax: 207-363-5573

ONTARIO

SUZY LOUW
Phone: 585-489-0272 Fax: 905-727-5893

WESTERN PA, NORTHERN WV

KEYSTONE MOUNTAINEER SALES
Phone: 724-228-5770 Fax: 724-228-0293

OH, KY, IN

TARGET SALES
Phone: 800-567-5045 Fax: 888-835-6373

FL

PAN AMERICAN SALES & MARKETING
Phone: 954-693-9688 Fax: 954-693-9683

IL

JAY HINDERSMAN
Phone: 630-460-5076 Fax: 630-871-1578

WI, MN

WSC - GREGG LIBBY
Phone/Fax: 414-453-6979

MI

PARADISE SALES
Phone: 313-294-7450 Fax: 313-294-7484

NM, UT, CO, WY, MO

ARCHITECTURAL DESIGN SALES
Phone: 866-671-8391 Fax: 303-755-7205

OR, WA, ID, AK

AMSG & ASSOCIATES
Phone: 503-52-8933 Fax: 503-520-9005

Northern CA, Nevada

THOMAS RAMOS & COMPANY
Phone: 831-429-9506 Fax: 831-426-1988

Locations not listed, please call Headquarters

CENTURY



Century Bathworks, Inc.™ ■ 250 Lackawanna Avenue ■ West Paterson, NJ 07424

973 785 4290 ■ 800 524 2578 ■ fax 973 785 0777

www.centurybathworks.com